

BENEFITS:

- High capacity for devices
- Cost saving
- Environmentally friendly

APPLICATIONS BEST FOR:

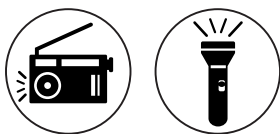

OTHER DETAILS:

- Nickel Metal Hydride chemistry
- Nominal voltage 1.2V
- Gross weight ~173g

BATTERY HANDLING

- Batteries should be charged prior to use.
- Remove batteries from the electrical device if the device is not going to be used for a long period of time.
- Do not mix new batteries in use with semi-used batteries.
- In order to maintain satisfactory cell / battery performance when being stored under extending period of time, fully charge the cell / battery every half year is highly recommended.



- **GP 9000 series Rechargeable battery**
- **D size**
- **Minimum capacity 9000mAh**

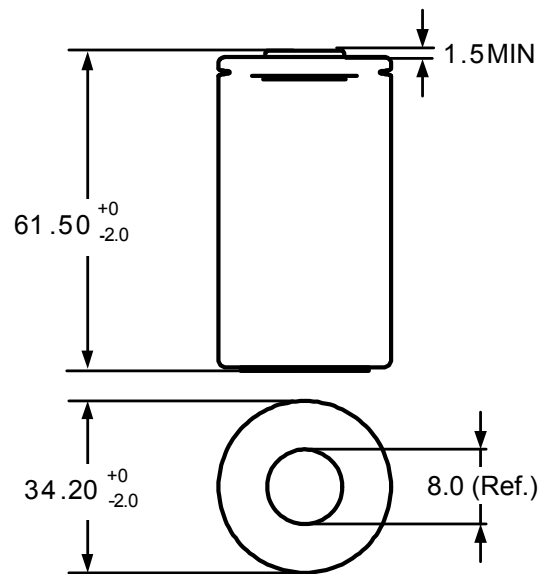

Unit : mm