

Major Ratings and Characteristics

Characteristics	Values	Units
$I_{F(AV)}$ Rectangular waveform	3.3	A
V_{RRM}	90/100	V
I_{FSM} @ $t_p = 5 \mu s$ sine	210	A
V_F @3Apk, $T_J = 25^\circ C$	0.85	V
T_J	-40 to 150	$^\circ C$

Description/ Features

The 31DQ.. axial leaded Schottky rectifier has been optimized for very low forward voltage drop, with moderate leakage. Typical applications are in switching power supplies, converters, free-wheeling diodes, and reverse battery protection.

- Low profile, axial leaded outline
- High purity, high temperature epoxy encapsulation for enhanced mechanical strength and moisture resistance
- Very low forward voltage drop
- High frequency operation
- Guard ring for enhanced ruggedness and long term reliability
- Lead-Free plating

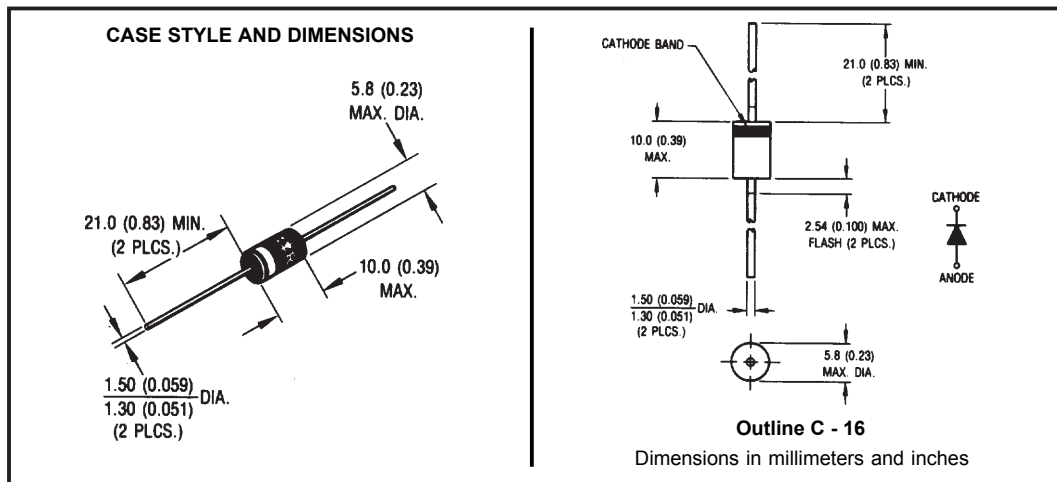

Voltage Ratings

Part number	31DQ09	31DQ10
V_R Max. DC Reverse Voltage (V)	90	100
V_{RWM} Max. Working Peak Reverse Voltage (V)		

Absolute Maximum Ratings

Parameters	31DQ..	Units	Conditions
$I_{F(AV)}$ Max. Average Forward Current * See Fig. 4	3.3	A	50% duty cycle @ $T_L = 108^\circ\text{C}$, rectangular wave form
I_{FSM} Max. Peak One Cycle Non-Repetitive Surge Current * See Fig. 6	210	A	Following any rated load condition and with rated V_{RRM} applied
	34		
E_{AS} Non-Repetitive Avalanche Energy	3.0	mJ	$T_J = 25^\circ\text{C}$, $I_{AS} = 1.0$ Amps, $L = 6$ mH
I_{AR} Repetitive Avalanche Current	0.5	A	Current decaying linearly to zero in 1 μsec Frequency limited by T_J max. $V_A = 1.5 \times V_R$ typical

Electrical Specifications

Parameters	31DQ..	Units	Conditions
V_{FM} Max. Forward Voltage Drop * See Fig. 1 (1)	0.85	V	@ 3A $T_J = 25^\circ\text{C}$
	0.97	V	@ 6A
	0.69	V	@ 3A $T_J = 125^\circ\text{C}$
	0.80	V	@ 6A
I_{RM} Max. Reverse Leakage Current * See Fig. 2 (1)	1	mA	$T_J = 25^\circ\text{C}$
	3	mA	$T_J = 125^\circ\text{C}$ $V_R = \text{rated } V_R$
C_T Typical Junction Capacitance	110	pF	$V_R = 5V_{DC}$ (test signal range 100Khz to 1Mhz) 25°C
L_S Typical Series Inductance	9.0	nH	Measured lead to lead 5mm from package body
dv/dt Max. Voltage Rate of Change	10000	V/ μs	(Rated V_R)

(1) Pulse Width < 300 μs , Duty Cycle <2%

Thermal-Mechanical Specifications

Parameters	31DQ..	Units	Conditions
T_J Max. Junction Temperature Range	-40 to 150	$^\circ\text{C}$	
T_{stg} Max. Storage Temperature Range	-40 to 150	$^\circ\text{C}$	
R_{thJA} Max. Thermal Resistance Junction to Ambient	80	$^\circ\text{C}/\text{W}$	DC operation Without cooling fins
R_{thJL} Typical Thermal Resistance Junction to Lead	15	$^\circ\text{C}/\text{W}$	DC operation
wt Approximate Weight	1.2 (0.042)	g (oz.)	
Case Style	C - 16		

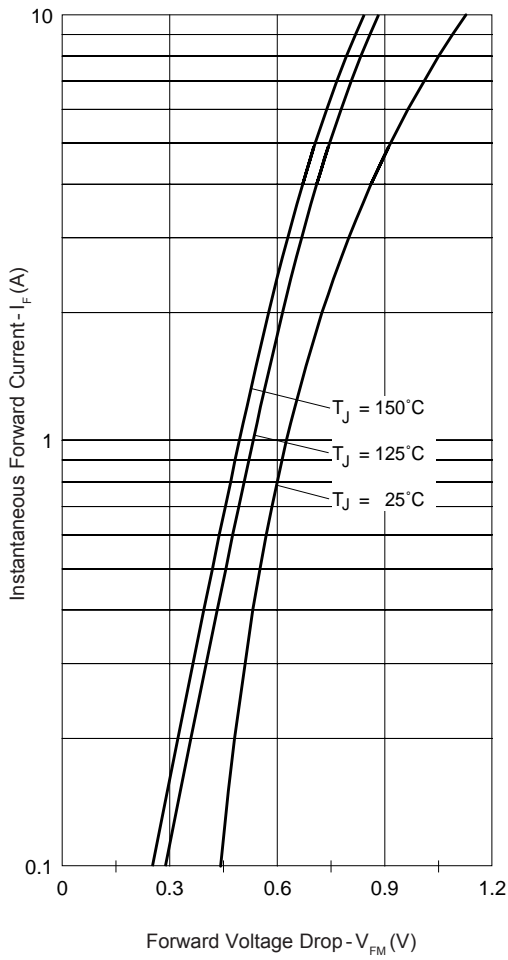

Fig. 1 - Max. Forward Voltage Drop Characteristics

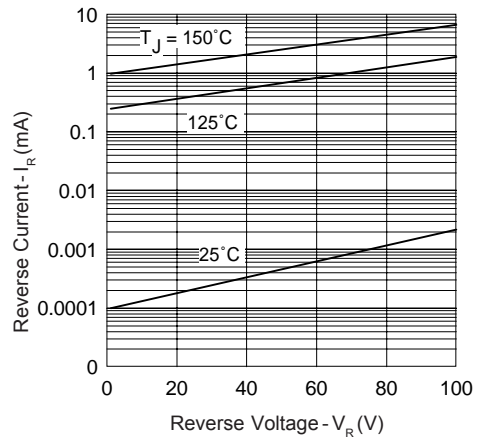

Fig. 2 - Typical Values Of Reverse Current Vs. Reverse Voltage

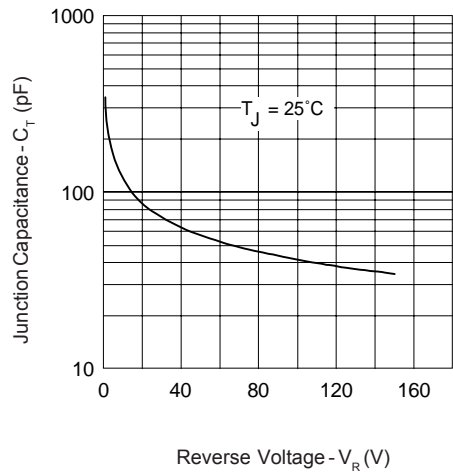

Fig. 3 - Typical Junction Capacitance Vs. Reverse Voltage

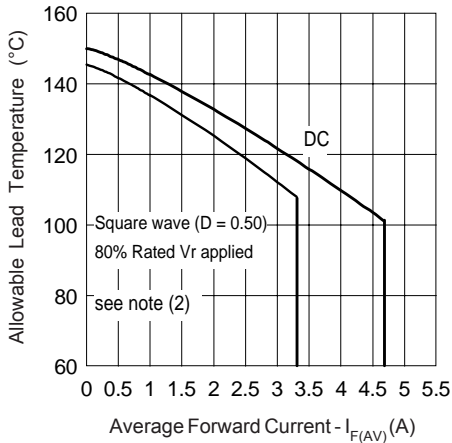

Fig. 4 - Max. Allowable Lead Temperature Vs. Average Forward Current

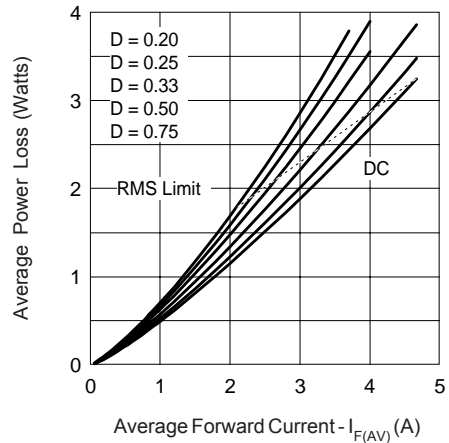

Fig. 5 - Forward Power Loss Characteristics

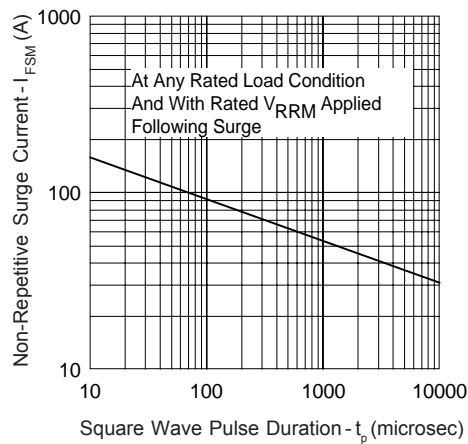

Fig. 6 - Max. Non-Repetitive Surge Current

(2) Formula used: $T_C = T_J - (P_d + P_{d_{REV}}) \times R_{thJL}$;

P_d = Forward Power Loss = $I_{F(AV)} \times V_{FM} @ (I_{F(AV)}/D)$ (see Fig. 6);

$P_{d_{REV}}$ = Inverse Power Loss = $V_{R1} \times I_R (1-D)$; $I_R @ V_{R1} = 80\%$ rated V_R

Ordering Information Table

Device Code											
	<table border="1" style="margin: auto;"> <tr> <td style="padding: 5px;">31</td> <td style="padding: 5px;">D</td> <td style="padding: 5px;">Q</td> <td style="padding: 5px;">10</td> <td style="padding: 5px;">TR</td> </tr> <tr> <td style="text-align: center;">①</td> <td style="text-align: center;">②</td> <td style="text-align: center;">③</td> <td style="text-align: center;">④</td> <td style="text-align: center;">⑤</td> </tr> </table>	31	D	Q	10	TR	①	②	③	④	⑤
31	D	Q	10	TR							
①	②	③	④	⑤							
1	- 31 = 3.3A (Axial and small packages - Current is x10)										
2	- D = DO-201 package										
3	- Q = Schottky Q.. Series										
4	- 10 = Voltage Ratings										
5	- • TR = Tape & Reel package (1200 pcs) • none = Box package (500 pcs)										

10 = 100V
 09 = 90V

```

31DQ10
*****
* SPICE Model Diode *
*****
.SUBCKT 31DQ10 ANO CAT
D1 ANO 1 CAT
*Define diode model
.MODEL DMOD D(Is=56.46E-06 N=2.202 Rs=28.27E-03 Ikf=0.5957 Xti=2 Eg=1.11
+ Cjo=199.3E-12 M=0.4572 Vj=1.873 Fc=0.5 Isr=165.6E-24 Nr=4.955
+ Bv=119.9 Ibv=215.5E-06 Tt=21.64E-09)
*****
.ENDS 31DQ10
  
```

Data and specifications subject to change without notice.
 This product has been designed and qualified for Industrial Level and Lead-Free.
 Qualification Standards can be found on IR's Web site.